

ULINE

PLASTIC AND FIBER OPEN TOP DRUMS

1-800-295-5510
uline.com

TOOLS NEEDED

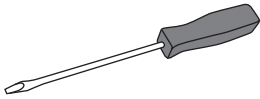

Flathead Screwdriver

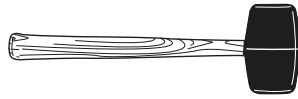

Rubber Mallet

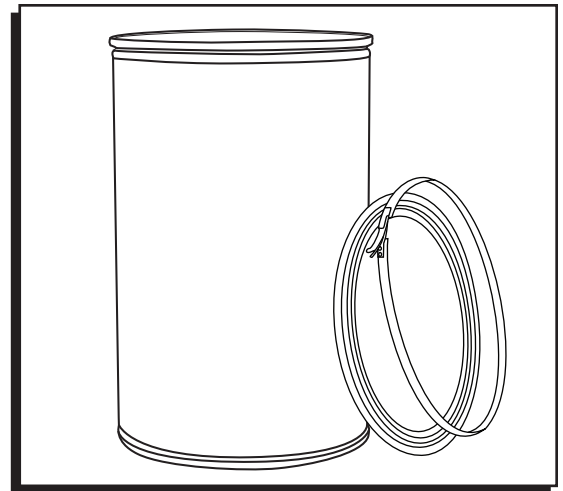

TROUBLESHOOTING

DIFFICULTY OPENING LEVER LOCK CLOSURE

 **NOTE:** Gloves should be worn when handling metal parts.

1. Place tip of screwdriver against the flat edge of the locking tab. (See Figure 1)

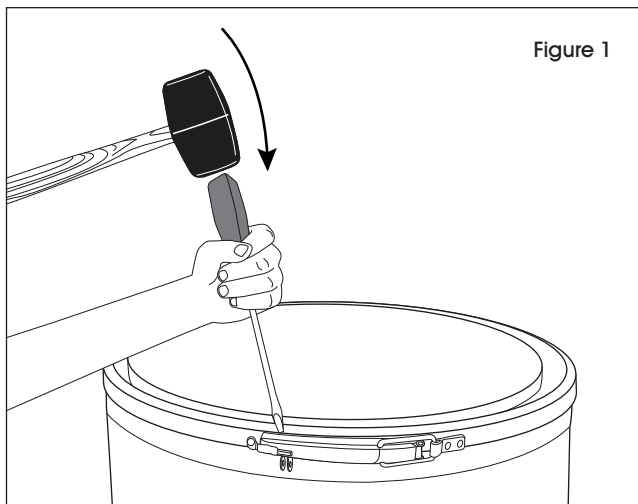

Figure 1

2. Strike the top of the screwdriver with a mallet. Locking tab will be forced down, releasing the handle. (See Figure 1)

3. Open handle and push backwards, freeing up the lockband. (See Figure 2)

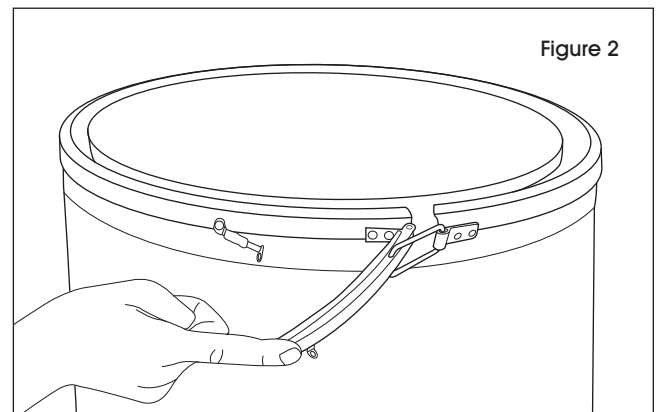

Figure 2

4. Remove and set aside lockband, keeping cover in place.
5. Slowly remove cover by forcing up one edge away from the drum at a time.
6. Lift cover off, making sure that no dirt particles fall into the drum.



CAUTION! Do not attempt to remove the lockband and cover at the same time. This may pull the stainless steel overlay off the drum's top chime.

ULINE

TAMBOS DE PLÁSTICO Y DE FIBRA CON PARTE SUPERIOR ABIERTA

800-295-5510
uline.mx

HERRAMIENTAS NECESARIAS

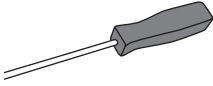

Desarmador de
Cabeza Plana

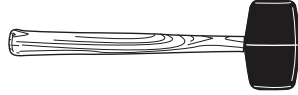

Mazo de Caucho

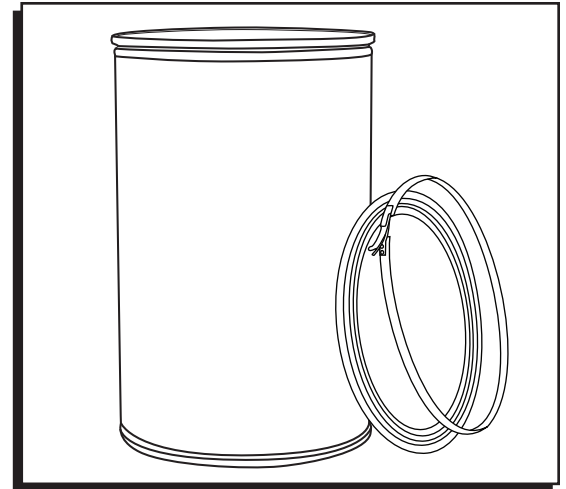

SOLUCIÓN DE PROBLEMAS

DIFICULTAD PARA ABRIR LA TAPA CON PALANCA

 **NOTA:** Debe usar guantes cuando maneje partes metálicas.

1. Coloque la punta del desarmador contra el lado plano de la pestaña de cierre. (Vea Diagrama 1)

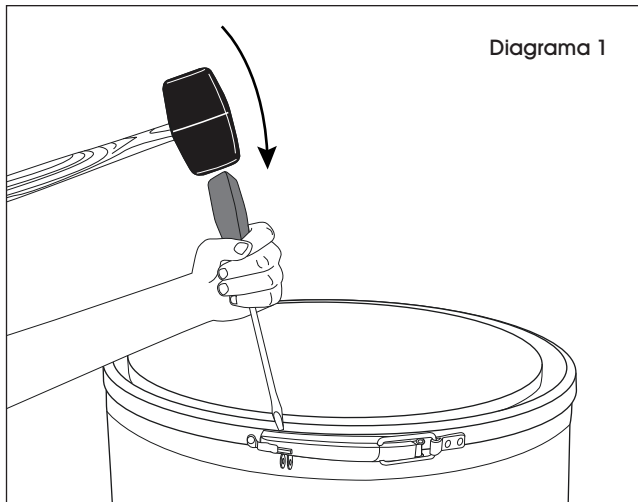

2. Golpee la parte superior del desarmador con un mazo. La pestaña de cierre se forzará hacia abajo, liberando la asa. (Vea Diagrama 1)

3. Jale el asa y empuje hacia atrás para liberar la banda de cierre. (Vea Diagrama 2)

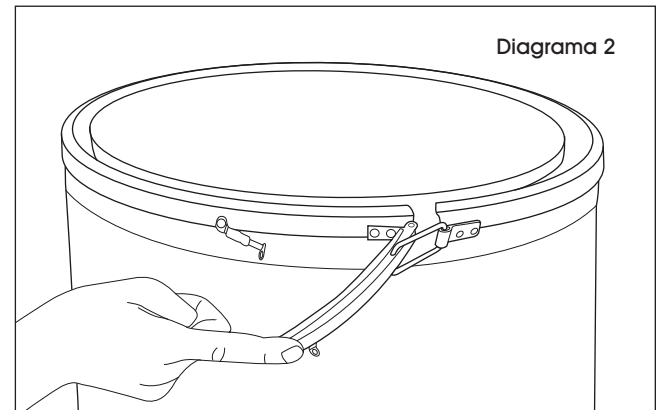

4. Retire y haga a un lado la banda de cierre, dejando la tapa en su lugar.
5. Retire de manera lenta la tapa levantando un borde del tambo a la vez.
6. Levante la tapa, asegurándose que no caigan partículas de suciedad dentro del tambo.



¡PRECAUCIÓN! No intente quitar la banda de cierre y la tapa al mismo tiempo. Esto puede desprender la cubierta de acero inoxidable del anillo superior del tambo.

ULINE

BARILS EN PLASTIQUE ET EN FIBRE À DESSUS OUVERT

1-800-295-5510
uline.ca

OUTILS REQUIS

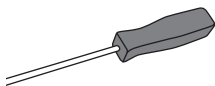

Tournevis à tête plate

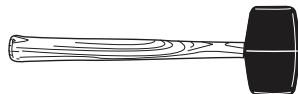

Maillet en caoutchouc

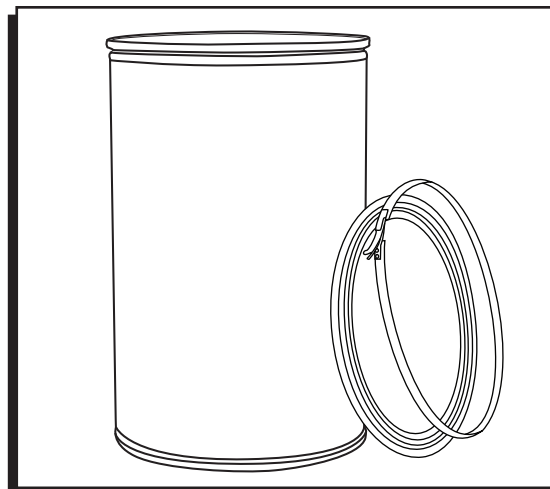

DÉPANNAGE

DIFFICULTÉ À OUVRIR LE LEVIER DE VERROUILLAGE

 **REMARQUE :** Il convient de porter des gants lors de la manipulation de pièces en métal.

1. Placez la pointe du tournevis contre le bord plat de la languette de blocage. (Voir Figure 1)

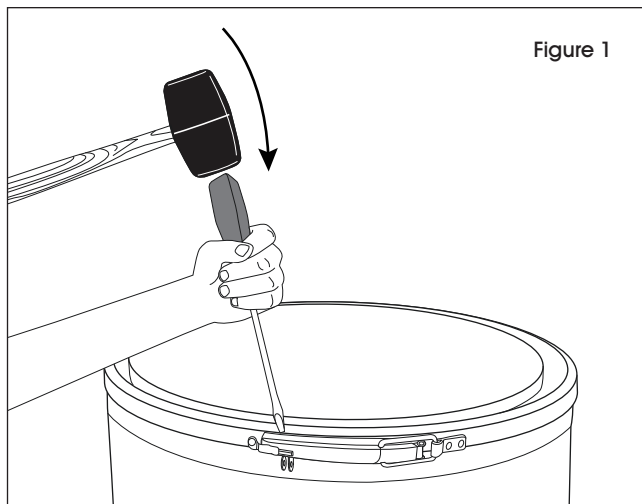

Figure 1

2. Frappez le tournevis à l'aide du maillet. La languette de blocage s'enfoncera dégageant ainsi la poignée. (Voir Figure 1)

3. Ouvrez la poignée et poussez vers l'arrière pour libérer l'anneau de verrouillage. (Voir Figure 2)

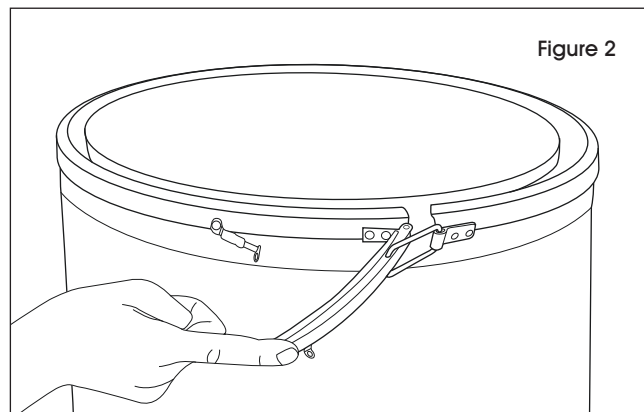

Figure 2

4. Enlevez et mettez de côté l'anneau de verrouillage en gardant le couvercle en place.
5. Retirez le couvercle en soulevant petit à petit les bords.
6. Lorsque vous soulevez le couvercle, assurez-vous qu'aucune saleté ne pénètre dans le baril.



MISE EN GARDE! Ne tentez pas de retirer l'anneau de verrouillage et le couvercle en même temps. Ceci pourrait écailler la couche en acier inoxydable se trouvant sur les rebords du baril.