

ULINE H-995 VINYL DUNNAGE INFLATOR GUN

1-800-295-5510
uline.com

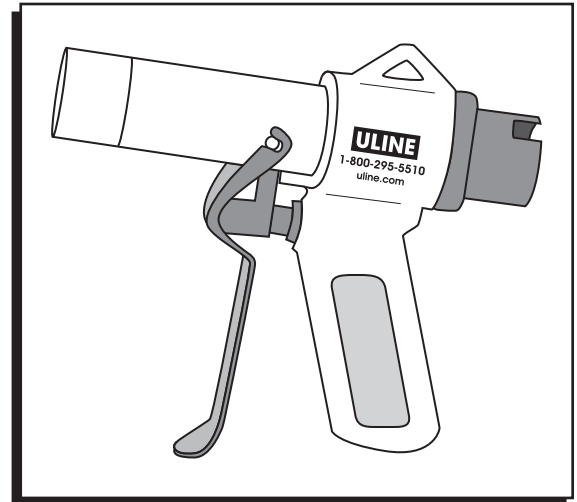

INFLATION

1. Twist cap off to open valve. (See Figure 1)

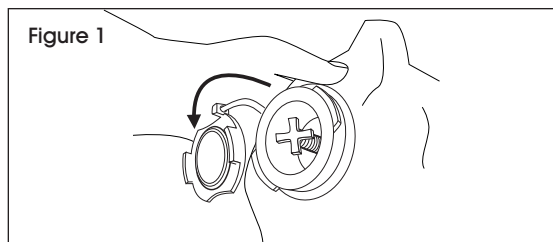

2. Make sure inner valve is closed. Valve is closed when the center pin is in the upright position. If open, turn cross clockwise until the spring pops up, closing the valve. (See Figure 2)

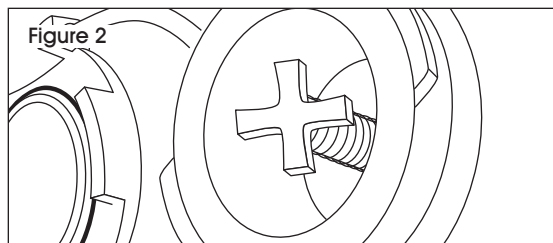

3. Press and hold the trigger to inflate the bag. Do not release the trigger; the bag cannot over-inflate. (See Figure 3)

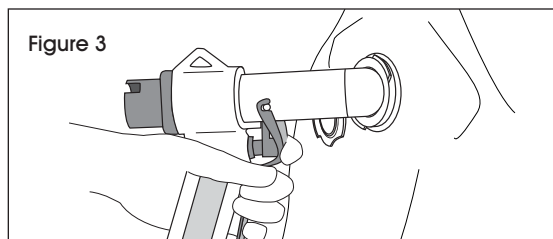

4. When air can be felt exiting the back of the gun, the Dunnage Bag is inflated and the gun may be removed. (See Figure 4)

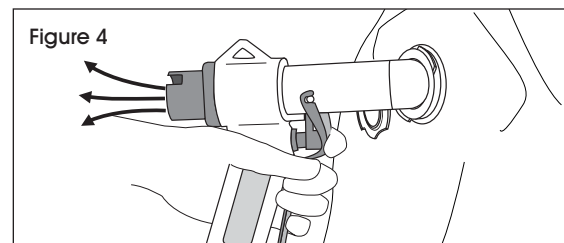

5. Wait until the gun is completely removed before releasing the trigger. (See Figure 5)

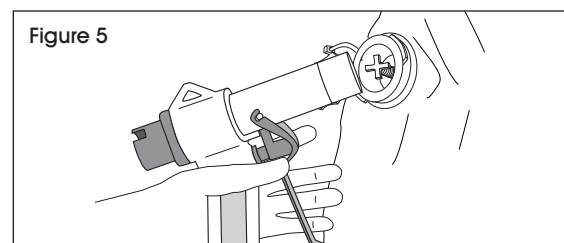

6. Close the cap on the valve. (See Figure 6)

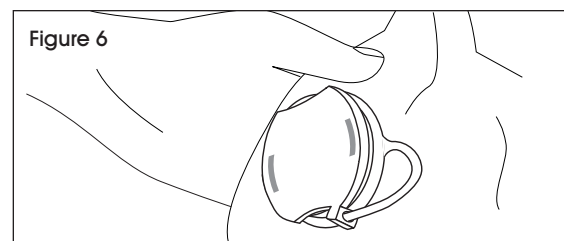

ULINE H-995

PISTOLA PARA INFLAR BOLSAS DE VINIL PARA CARGA

800-295-5510
uline.mx

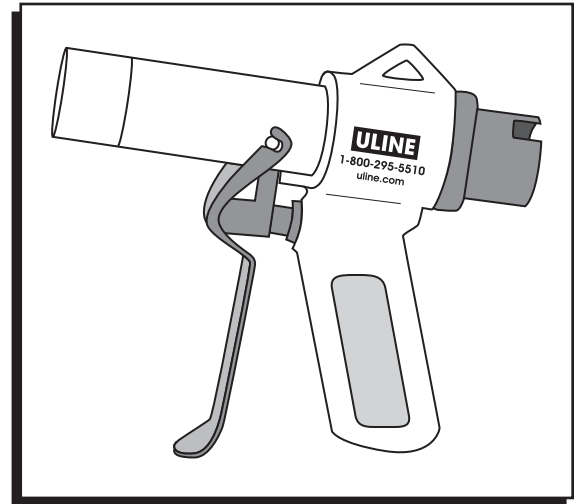

INFLADO

1. Gire la tapa para abrir la válvula. (Vea Diagrama 1)

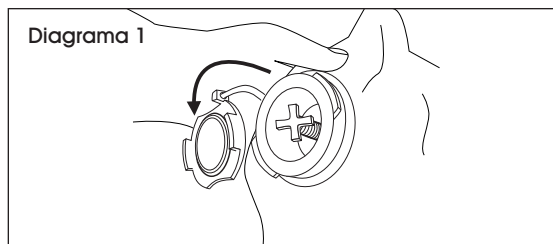

2. Asegúrese de que la válvula interior esté cerrada. La válvula está cerrada cuando la clavija central está en posición vertical. Si está abierta, gire la cruz en el sentido de las agujas del reloj hasta que el resorte haga pop, cerrando la válvula. (Vea Diagrama 2)

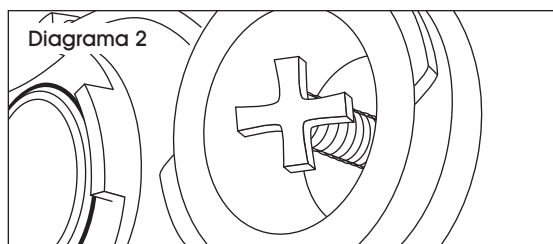

3. Presione y mantenga presionado el gatillo para inflar la bolsa. No suelte el gatillo, la bolsa no se puede inflar de más. (Vea Diagrama 3)

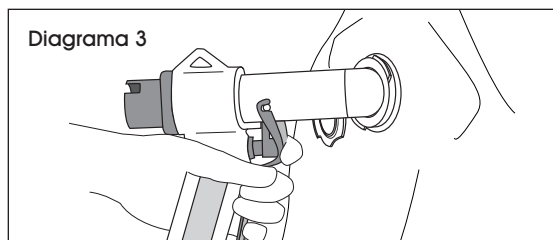

4. Cuando se sienta aire saliendo por la parte posterior de la pistola, la bolsa de aire para carga estará inflada y puede retirar la pistola. (Vea Diagrama 4)

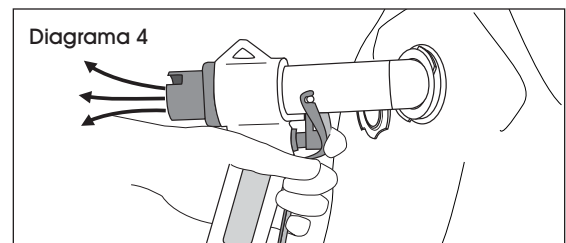

5. Espere hasta haber retirado completamente la pistola antes de liberar el gatillo. (Vea Diagrama 5)

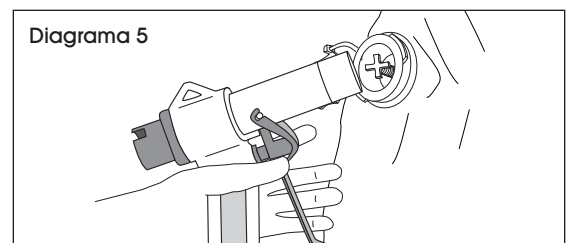

6. Cierre la tapa de la válvula. (Vea Diagrama 6)

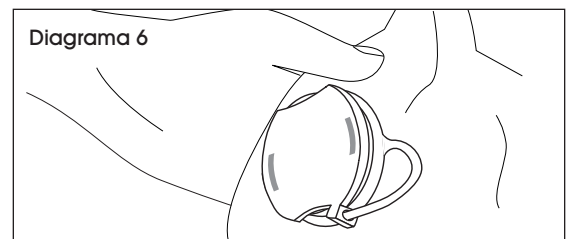

ULINE H-995

PISTOLET GONFLEUR POUR SACS DE FARDAGE EN VINYLE

1-800-295-5510
uline.ca

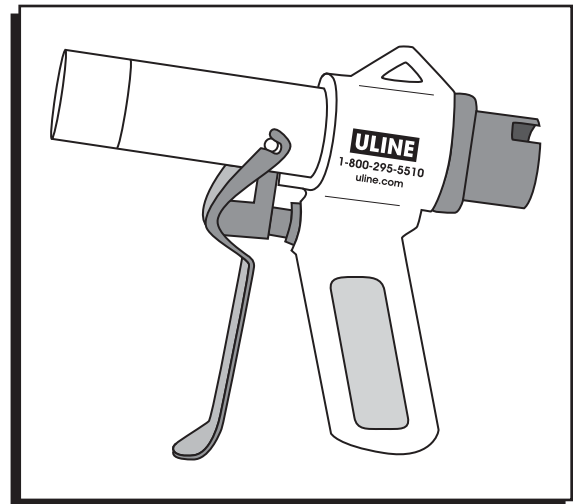

GONFLAGE

1. Tournez le bouchon pour ouvrir la valve.
(Voir Figure 1)

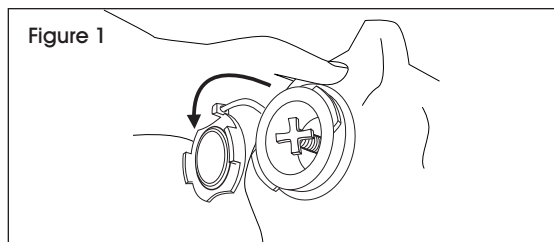

2. Assurez-vous que la valve intérieure est fermée. La valve est fermée lorsque la tige du centre est en position verticale. Si elle est ouverte, tournez la croix dans le sens horaire jusqu'à ce que le ressort avance; la valve se fermera. (Voir Figure 2)

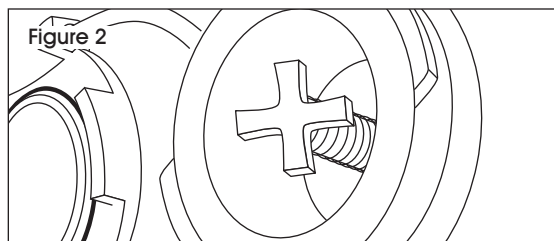

3. Maintenez la détente enfoncée pour gonfler le sac. Ne relâchez pas la détente, car il est impossible de surgonfler le sac. (Voir Figure 3)

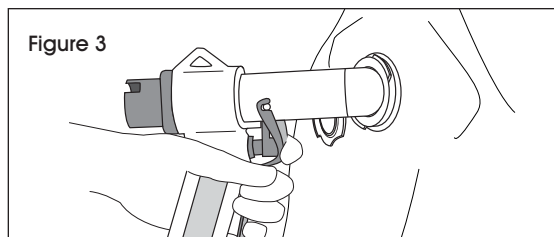

4. Lorsque vous sentez l'air sortir de l'arrière du pistolet, le sac à fardage est gonflé et le pistolet peut être retiré. (Voir Figure 4)

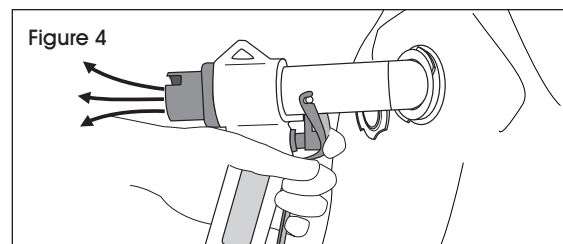

5. Attendez que le pistolet soit complètement retiré avant de relâcher la détente. (Voir Figure 5)

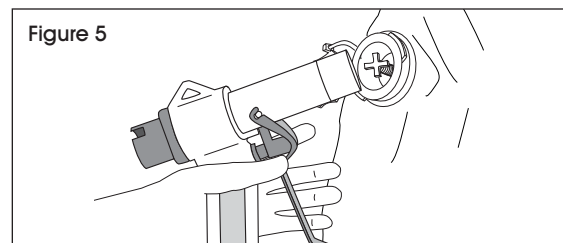

6. Refermez le bouchon de la valve. (Voir Figure 6)

