

ULINE

BLACK WIRE SHELVING

1-800-295-5510
uline.com

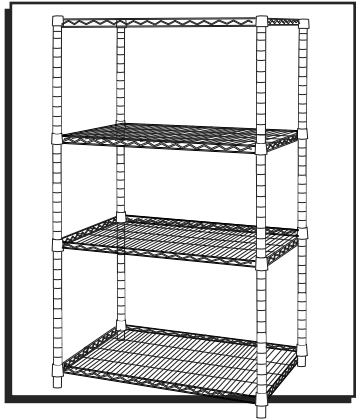

TOOL NEEDED



Rubber Mallet

SHELF PARTS

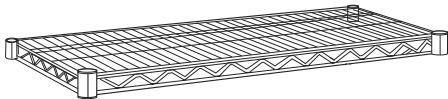

Shelf x 4



Shelf Support x 16 Sets



NOTE: Two-shelf wire shelving units include two shelves and eight sets of shelf supports.

POST PARTS

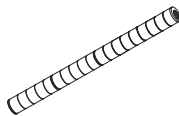

Post x 4



Self-Leveling Foot x 4



NOTE: Self-leveling feet are located within post carton.

SELF-LEVELING FEET OR CASTER INSTALLATION

SELF-LEVELING FEET



NOTE: If installing casters, do not install self-leveling feet.

1. Ensure post is positioned as shown. (See Figure 1)
2. Insert self-leveling foot into open end of post.
3. Use a rubber mallet/hammer or tap on ground until self-leveling foot slides into post.
4. Repeat steps 2 and 3 for remaining posts.

CASTERS (ULINE MODEL # H-1205WH SOLD SEPARATELY)

1. Ensure post is positioned as shown. (See Figure 2)
2. Engage the wheel brakes to keep casters from rolling during assembly. Use a rubber mallet to tap caster stems into posts. (See Figure 2)

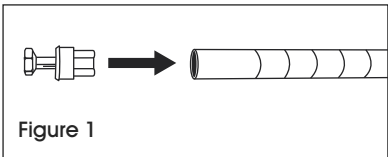

Figure 1

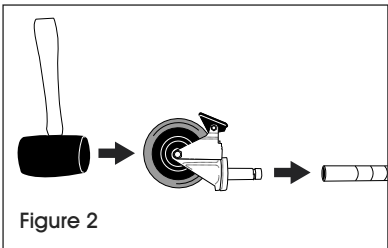

Figure 2

ASSEMBLY

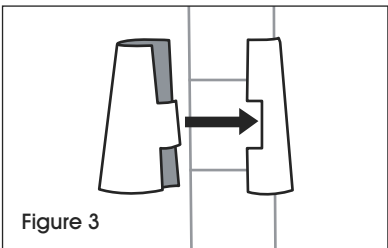

Figure 3

1. Start with the lowest shelf. Snap the interlocking pieces of a shelf support (wide end down) around the post at the lowest groove where shelf is to be located. Slide the support up or down until it snaps onto the groove. Add a shelf support to the same place on the remaining posts. (See Figure 3)



NOTE: NSF requires food service applications to keep the lowest shelf at least 6" above the floor.

INSTRUCTIONS FOR UNIT ASSEMBLY (CONTINUED)

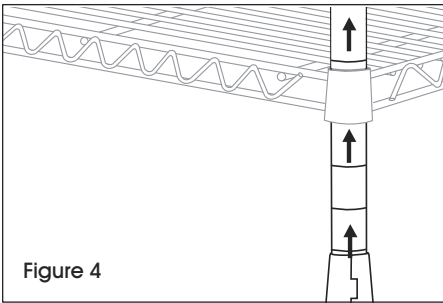

2. Start with the lowest shelf. Snap the interlocking pieces of a shelf support (wide end down) around the post at the lowest groove where shelf is to be located. Slide the support up or down until it snaps onto the groove. Add a shelf support to the same place on the remaining posts. (See Figure 3)



NOTE: NSF requires food service applications to keep the lowest shelf at least 6" above the floor.

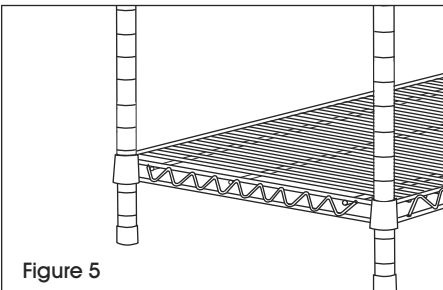

3. Slide post through underside of shelf until shelf slides firmly over supports. (See Figure 4)

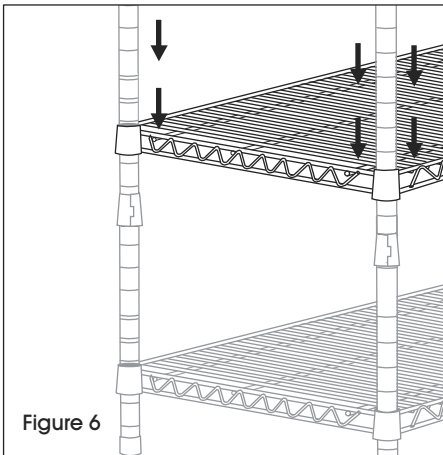

4. Stand unit upright. Gently tap shelf down to secure it. (See Figure 5)

INSTRUCTIONS FOR ADD-ON UNIT ASSEMBLY

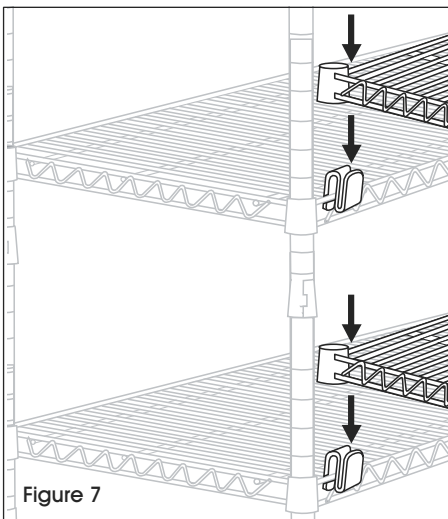

5. Determine the height of the next shelf, snap on supports then add and secure shelf. Repeat Step 4 to add the remaining shelves. (See Figure 6)

1. ASSEMBLE ADD-ON SHELVES:

Follow steps 1-4 of assembly to attach shelves to add-on legs.



NOTE: Ensure add-on shelves are installed at same height as existing shelves.

2. ATTACH ADD-ON ASSEMBLY TO EXISTING SHELVES:

Install two S-hooks over shelf edges on each shelf of the main unit. Repeat for each add-on shelf being attached. (See Figure 7)

Insert add-on unit shelf edges into open ends of S-hooks. Repeat for each add-on shelf being attached. (See Figure 7)

ULINE

1-800-295-5510

uline.com

ULINE

ESTANTERÍA DE ALAMBRE NEGRO

800-295-5510

uline.mx

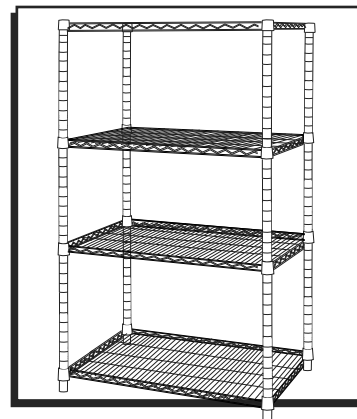

HERRAMIENTA NECESARIA



Mazo de Caucho

PARTES DE LA REPISA

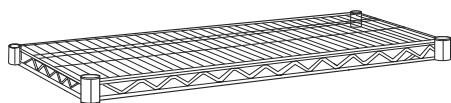

Repisa x 4



Soporte de Repisa
x Set de 16



NOTA: Las unidades de estantería de alambre de dos repisas incluyen 2 repisas y 8 sets de soportes de repisa.

PARTES DEL POSTE

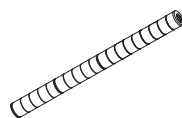

Poste x 4

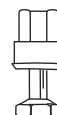

Autonivelador x 4



NOTA: Las patas autoniveladoras están adentro de la caja de cartón.

INSTALACIÓN DE AUTONIVELADORES O RUEDAS



Diagrama 1



Diagrama 2

AUTONIVELADORES

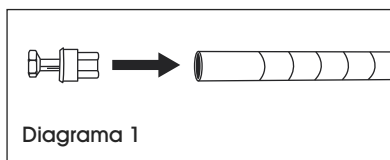

NOTA: Si va a instalar ruedas, no instale autoniveladores.

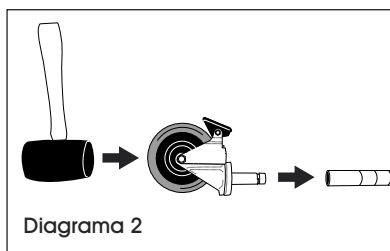
1. Asegúrese de que los postes estén posicionados como se muestra. (Vea Diagrama 1)
2. Inserte el autonivelador dentro del extremo abierto del poste.
3. Utilice un martillo, mazo de caucho o golpee contra el piso hasta que el autonivelador se deslice dentro del poste.
4. Repita los pasos 2 y 3 para los otros postes.

RUEDAS (ULINE MODELO# H-1205WH SE VENDE POR SEPARADO)

1. Asegúrese de que el poste esté posicionado como se muestra. (Vea Diagrama 2)
2. Ponga el seguro en las llantas para evitar que se rueden durante el ensamble. Utilice un mazo de caucho para insertar el vástago de las ruedas dentro de los postes. (Vea Diagrama 2)

ENSAMBLE



Diagrama 3

1. Comience con la repisa más baja. Embone las piezas del soporte para repisa (la parte ancha hacia abajo) alrededor del poste en la ranura más baja donde se colocará la repisa. Deslice el soporte hacia arriba o abajo hasta que embone en la ranura. Agregue un soporte para repisa en el mismo lugar en los postes restantes. (Vea Diagrama 3)

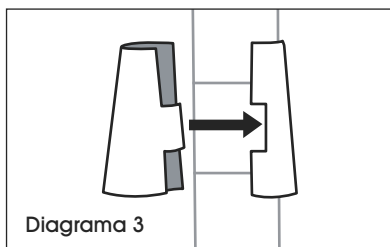

NOTA: NSF requiere que para aplicaciones en servicio de alimentos mantenga la repisa más baja al menos 15 cm (6") sobre el piso.

CONTINUACIÓN DE ENSAMBLE

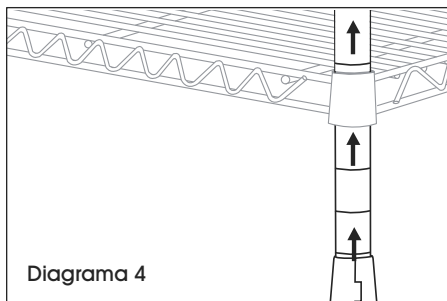

2. Deslice el poste a través de la parte inferior de la repisa hasta que la repisa se deslice firmemente por encima de los soportes. (Vea Diagrama 4)

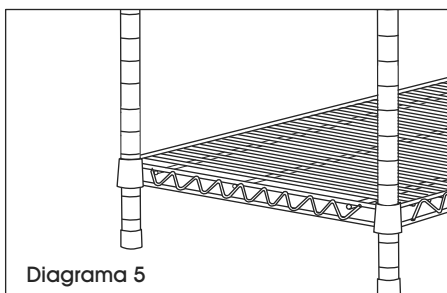

3. Enderece la unidad. Presione ligeramente la repisa para asegurarla. (Vea Diagrama 5)

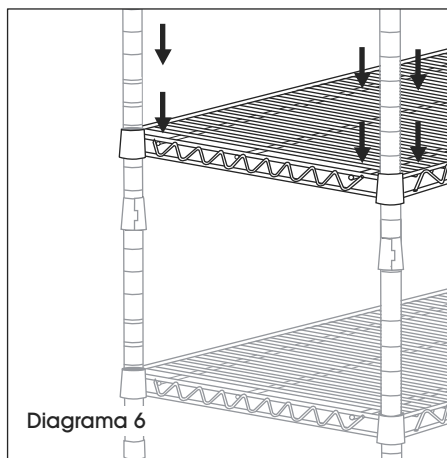

4. Determine la altura de la siguiente repisa, ajuste los soportes al poste y luego agregue y asegure la repisa. Repita para las repisas restantes. (Vea Diagrama 6)

INSTRUCCIONES PARA ENSAMBLAR LA UNIDAD COMPLEMENTARIA

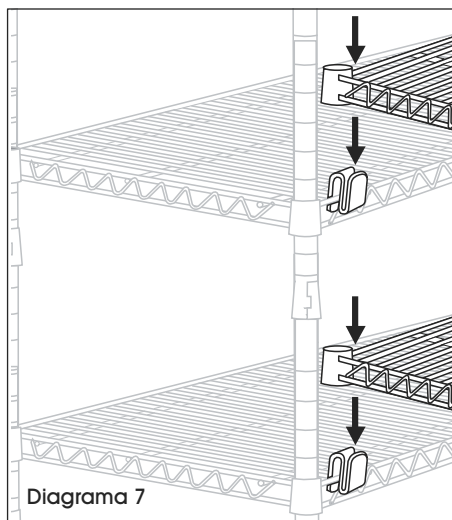

1. **ENSAMBLE LAS REPISAS DE LA UNIDAD COMPLEMENTARIA:**
Siga los pasos 1-4 para ensamblar las repisas en las 2 patas complementarias.



NOTA: Asegúrese de que las repisas complementarias estén instaladas al mismo nivel de las repisas existentes.

2. **FIJE EL ENSAMBLE DE LAS UNIDADES COMPLEMENTARIAS A LAS REPISAS EXISTENTES:**
Instale dos ganchos en S sobre los bordes de cada repisa de la unidad principal. Repita por cada repisa complementaria que se agregue. (Vea Diagrama 7)

Inserte los bordes de las repisas de la unidad complementaria en los extremos abiertos de los ganchos en S. Repita por cada repisa complementaria que se agregue. (Vea Diagrama 7)

ULINE

800-295-5510
uline.mx

ULINE

RAYONNAGE MÉTALLIQUE NOIR

1-800-295-5510

uline.ca

OUTIL REQUIS



Maillet en caoutchouc

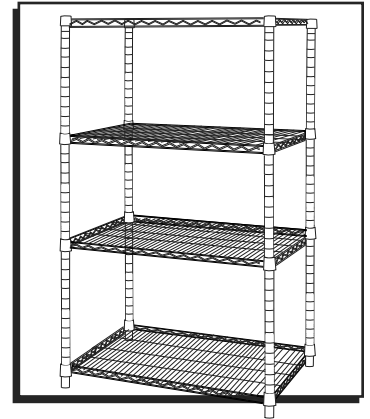

PIÈCES DES TABLETTES

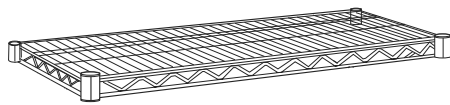

Tablette x 4



Ensemble de support
de tablette x 16



REMARQUE : Les rayonnages en fil de métal à deux tablettes comprennent 2 tablettes et 8 ensembles de supports de tablette.

PIÈCES DES MONTANTS

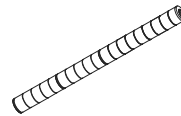

Montant x 4



Pattes autonivelantes x 4



REMARQUE : Les pattes autonivelantes sont incluses dans le carton avec les montants.

INSTALLATION DES PATTES AUTONIVELANTES OU DES ROULETTES

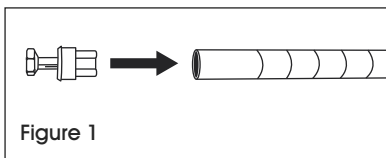

Figure 1

PATTES AUTONIVELANTES



REMARQUE : Si vous installez des roulettes, n'installez pas de pattes autonivelantes.

1. Assurez-vous que le montant est placé comme illustré. (Voir Figure 1)
2. Insérez la patte autonivelante dans l'extrémité ouverte du montant.
3. Utilisez un marteau/maillet en caoutchouc ou tapotez le montant sur le sol jusqu'à ce que la patte autonivelante se glisse à l'intérieur.
4. Répétez les étapes 2 et 3 pour tous les autres montants.

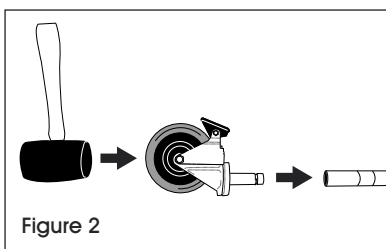

Figure 2

ROULETTES (N° DE MODÈLE ULINE H-1205WH, VENDU SÉPARÉMENT)

1. Assurez-vous que le montant est placé comme illustré. (Voir Figure 2)
2. Enclenchez le frein des roues pour empêcher les roulettes de rouler pendant le montage. Utilisez un maillet en caoutchouc pour insérer la tige des roulettes dans les montants. (Voir Figure 2)

MONTAGE

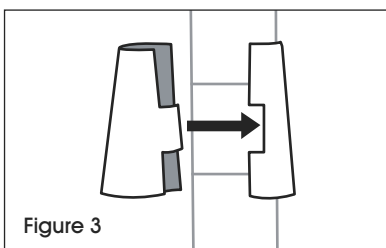

Figure 3

1. Commencez par la tablette la plus basse. Enclenchez les pièces emboîtables d'un support de tablette (extrémité la plus large vers le bas) autour du montant, au niveau de la rainure la plus basse où la tablette doit être installée. Faites glisser le support vers le haut ou vers le bas jusqu'à ce qu'il s'enclenche sur la rainure. Ajoutez un support de tablette au même emplacement sur les montants restants. (Voir Figure 3)



REMARQUE : Pour les applications alimentaires, la NSF stipule que la tablette la plus basse doit se trouver à 15 cm (6 po) du sol.

MONTAGE SUITE

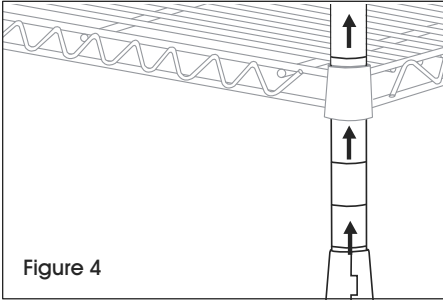

Figure 4

2. Insérez le montant par le dessous de la tablette jusqu'à ce que la tablette glisse fermement sur les supports. (Voir Figure 4)

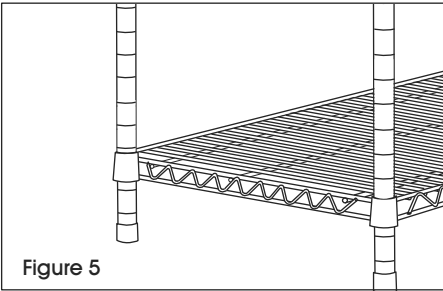

Figure 5

3. Placez l'unité à la verticale. Tapotez délicatement la tablette vers le bas pour la fixer. (Voir Figure 5)

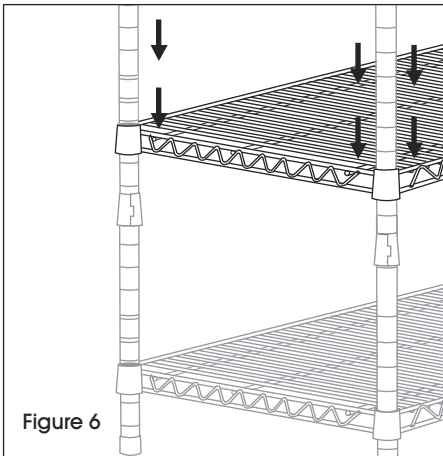

Figure 6

4. Déterminez la hauteur de la tablette suivante, enclenchez les supports, puis ajoutez et fixez la tablette. Répétez l'étape 4 pour ajouter les tablettes restantes. (Voir Figure 6)

MONTAGE DE L'UNITÉ COMPLÉMENTAIRE

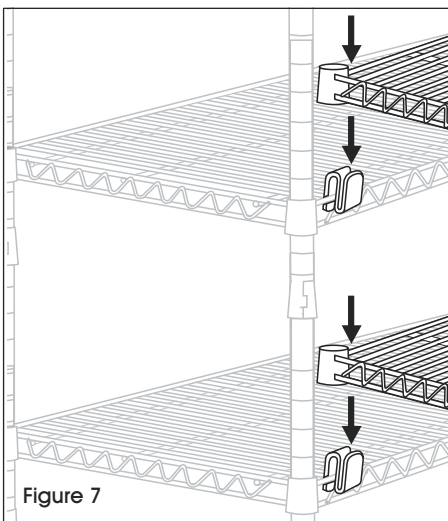

Figure 7

1. MONTAGE DES TABLETTES COMPLÉMENTAIRES :

Reportez-vous aux étapes 1 à 4 pour l'installation des tablettes sur les montants de l'unité complémentaire.



REMARQUE : Assurez-vous que les tablettes complémentaires sont installées au même niveau que les tablettes existantes.

2. FIXATION DE L'UNITÉ COMPLÉMENTAIRE AUX TABLETTES EXISTANTES :

Installez deux crochets en S sur les bords de chaque tablette de l'unité de base. Répétez la procédure pour chaque tablette complémentaire ajoutée. (Voir Figure 7)

Insérez les bords de tablette de l'unité complémentaire dans les extrémités ouvertes des crochets en S. Répétez la procédure pour chaque tablette complémentaire ajoutée. (Voir Figure 7)

ULINE

1-800-295-5510

uline.ca