

PARTS

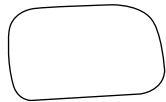

Back Cushion x 1



Back Cushion Post x 1

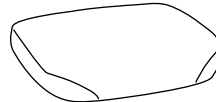

Seat Cushion x 1

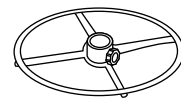

Footring x 1



Gas Lift x 1

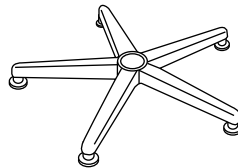

5-Star Base x 1



Glide x 5

ASSEMBLY

1. Insert glides into legs of five-star base. Turn base upright. Insert gas lift into center of base. (See Figure 1)

Figure 1

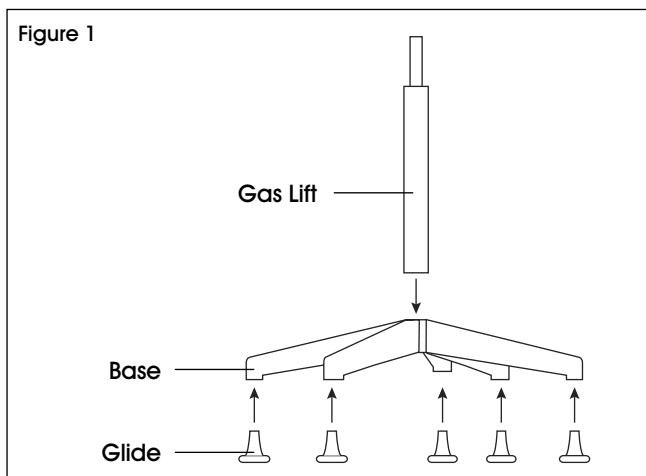

2. Slide footring onto the gas lift and tighten knob to secure. (See Figure 2)

Figure 2

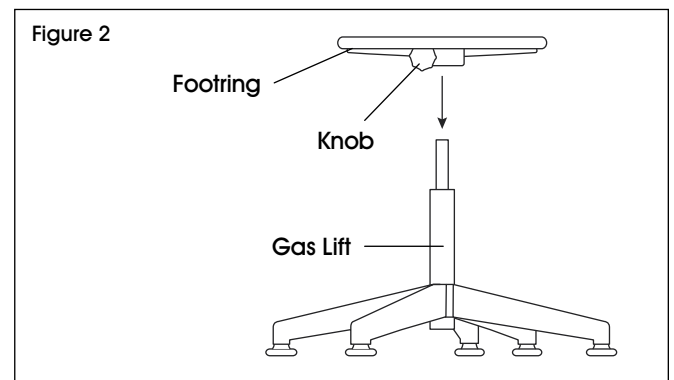

ASSEMBLY CONTINUED

- Loosen knob on mechanism on bottom of seat cushion. Insert back cushion post into corresponding slot on mechanism and tighten knob to secure. (See Figure 3)

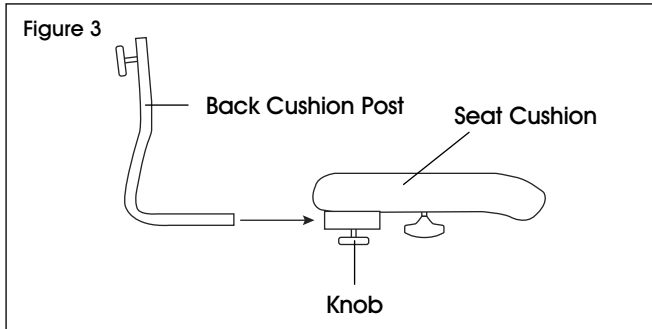

- Align back cushion with post and use knob to attach loosely through slot. Set back cushion at preferred height and tighten knob to secure. (See Figure 4)

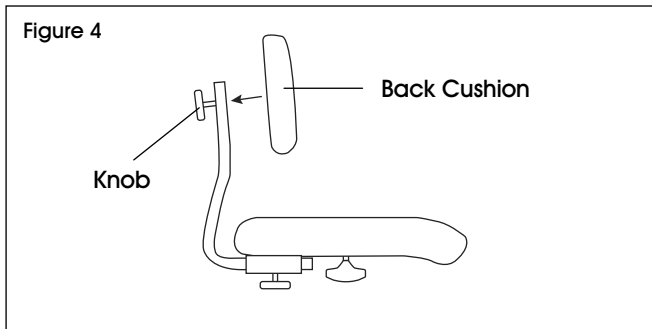

- Slowly lower stool assembly onto the gas lift. Press down on seat to secure. (See Figure 5)

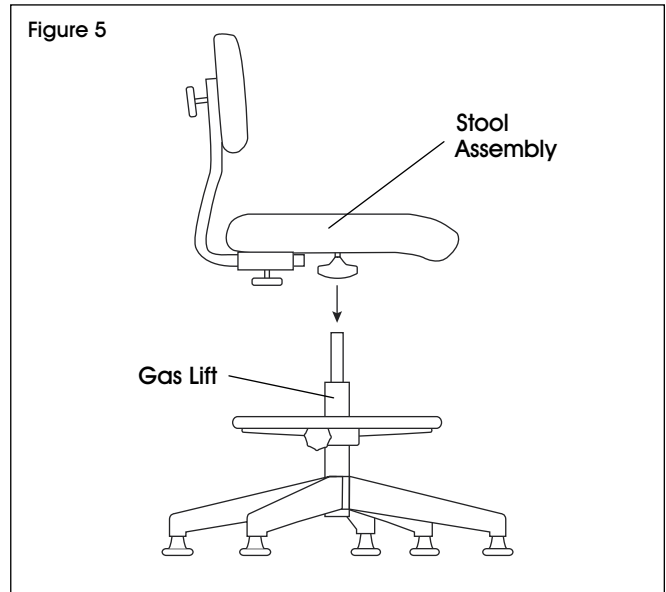

STOOL ADJUSTMENTS

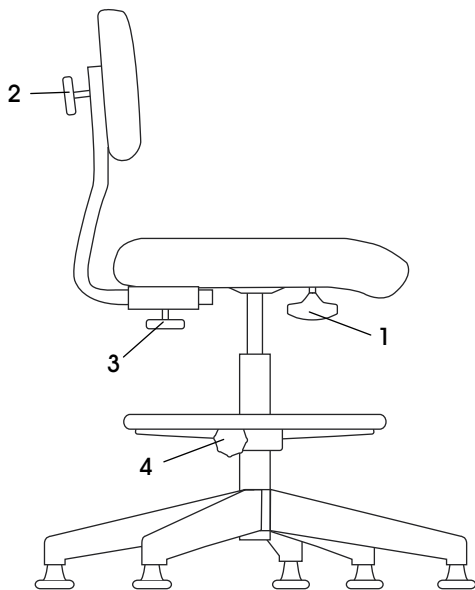

- Seat Height Adjustment** – To raise seat height, lift lever up with little to no weight on the seat. To lower seat height, lift lever up while sitting.
- Back Height** – To adjust back height, loosen knob and slide the back up or down. Set back at preferred height and tighten knob to secure.
- Seat Depth** – To adjust seat depth, loosen knob and slide the back in or out. Set back at preferred seat depth and tighten knob to secure.
- Footring Height** – To adjust footring height, loosen knob and slide the footring up or down. Set footring at preferred height and tighten knob to secure.

ULINE

1-800-295-5510
uline.com

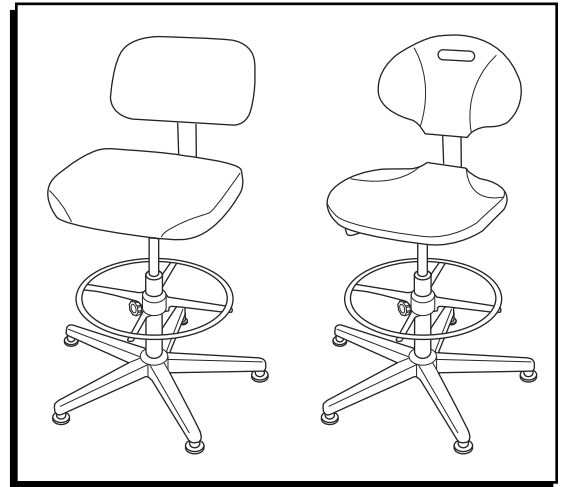
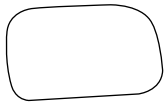
**PARTES**

1 Respaldo Acojinado



1 Poste del Respaldo

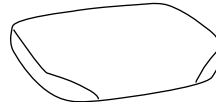

1 Asiento Acojinado

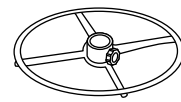

1 Reposapiés



1 Pistón de Gas

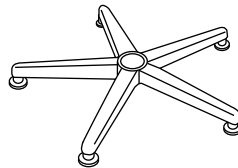

1 Base Estrella



5 Niveladores

ENSAMBLE

1. Inserte los niveladores en las patas de la base estrella. Enderece la base. Inserte el pistón de gas en el centro de la base. (Vea Diagrama 1)

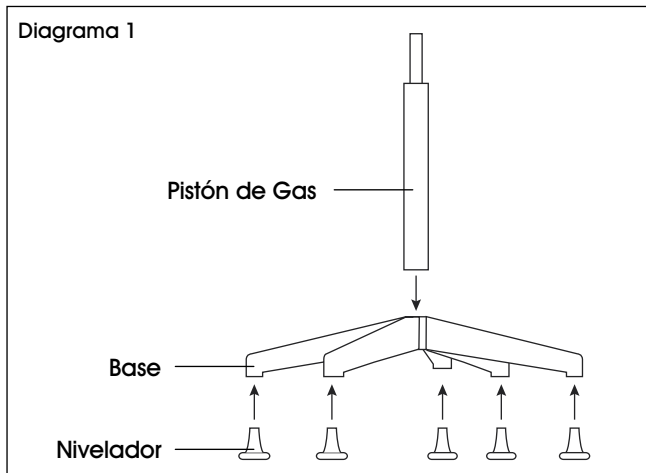

2. Inserte el reposapiés en el pistón de gas y apriete la perilla para asegurarlo. (Vea Diagrama 2)

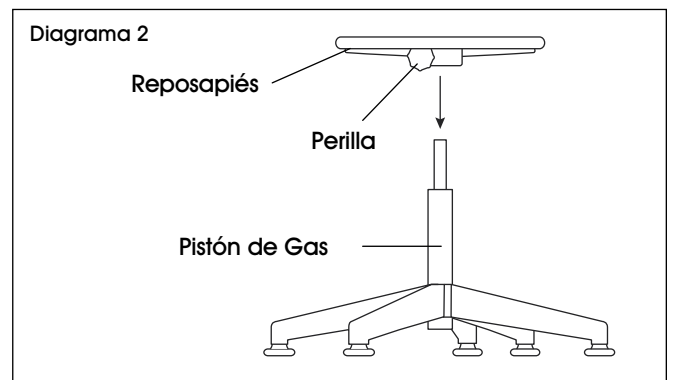

CONTINUACIÓN DEL ENSAMBLE

3. Afloje la perilla del mecanismo en la parte inferior del asiento. Inserte el poste del respaldo acojinado en la ranura correspondiente del mecanismo y apriete la perilla para asegurarlo. (Vea Diagrama 3)

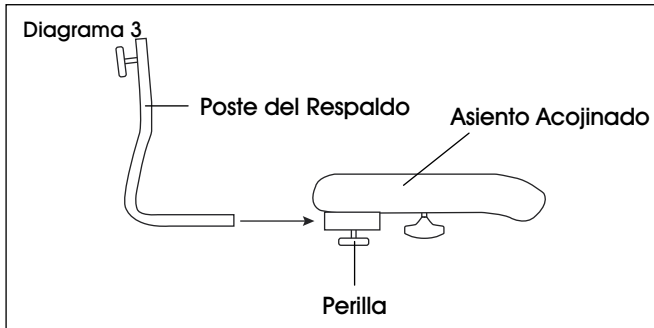

4. Alinee el respaldo acojinado con el poste y use la perilla para fijarlo sin apretar a través de la ranura. Coloque el respaldo acojinado a la altura deseada y apriete la perilla para asegurarlo. (Vea Diagrama 4)

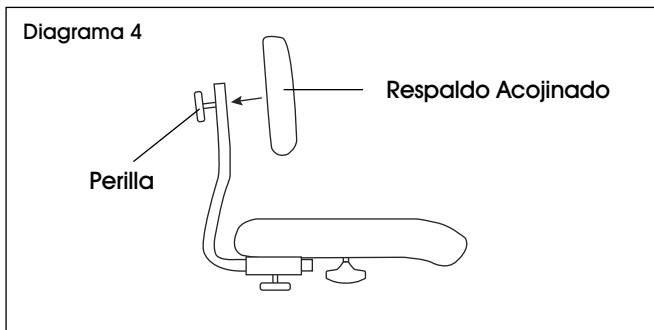

5. Baje lentamente el ensamble de la silla sobre el pistón de gas. Presione el asiento para asegurarlo. (Vea Diagrama 5)



AJUSTES DE LA SILLA DE TRABAJO

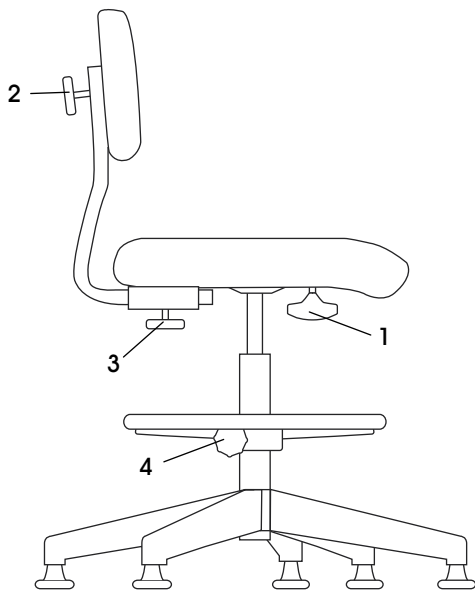

1. Ajuste de la Altura del Asiento – Para subir la altura del asiento, levante la palanca sin o con poco peso en el asiento. Para bajar la altura del asiento, levante la palanca mientras está sentado.
2. Altura del Respaldo – Para ajustar la altura del respaldo, afloje la perilla y deslícelo hacia arriba o abajo. Coloque el respaldo a la altura deseada y apriete la perilla para asegurarlo.
3. Profundidad del Asiento – Para ajustar la profundidad del asiento, afloje la perilla y deslice el respaldo hacia adentro o afuera. Coloque el respaldo a la profundidad del asiento deseada y apriete la perilla para asegurarlo.
4. Altura del Reposapiés – Para ajustar la altura del reposapiés, afloje la perilla y deslícelo hacia arriba o abajo. Coloque el reposapiés a la altura deseada y apriete la perilla para asegurarlo.

ULINE

800-295-5510

uline.mx

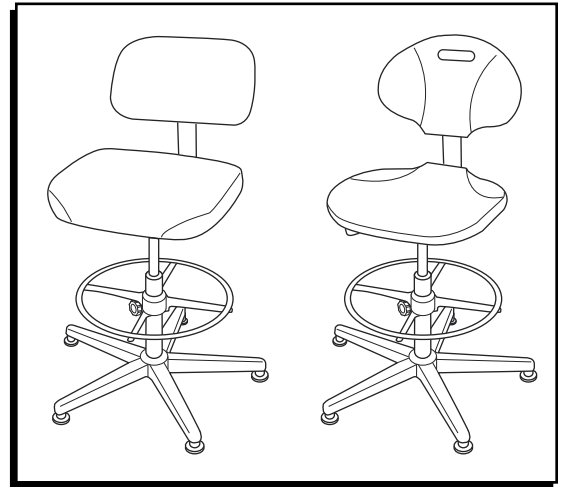
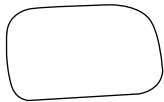
**PIÈCES**

Dossier x 1



Montant de dossier x 1

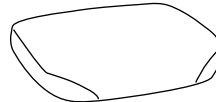

Siège x 1

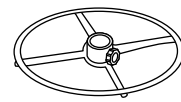

Repose-pied x 1



Vérin pneumatique x 1

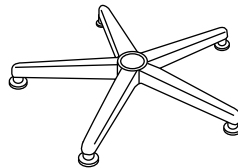

Base à 5 branches x 1



Patin x 5

ASSEMBLAGE

1. Insérez les patins dans les pieds de la base à cinq branches. Tournez la base à l'endroit. Insérez le vérin pneumatique dans le centre de la base. (Voir Figure 1)
2. Faites glisser le repose-pied sur le vérin pneumatique et serrez la molette pour le fixer. (Voir Figure 2)

Figure 1

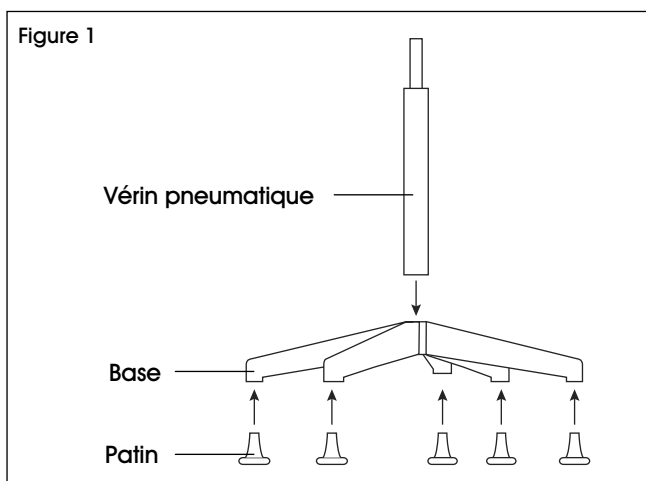
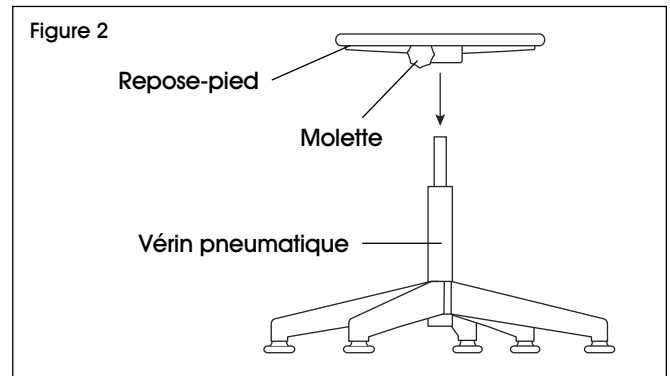
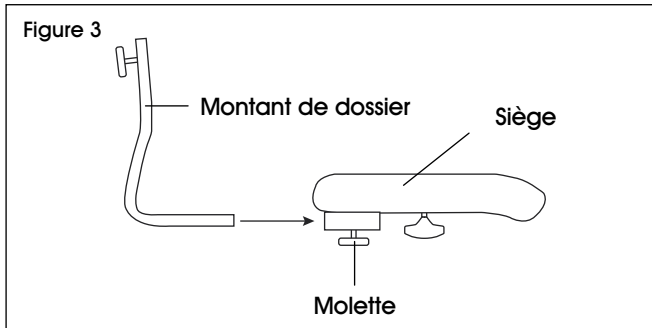

Figure 2



ASSEMBLAGE (SUITE)

3. Desserrez la molette du mécanisme sous le siège. Insérez le montant de dossier dans la fente correspondante du mécanisme et serrez la molette pour le fixer. (Voir Figure 3)



4. Alignez le dossier sur le montant et fixez-le sans serrer à travers la fente en vous servant de la molette. Réglez le dossier à la hauteur désirée et serrez la molette pour le fixer. (Voir Figure 4)

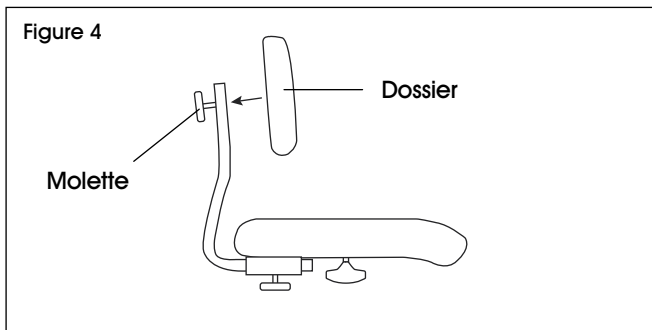

5. Abaissez lentement le tabouret sur le vérin pneumatique. Appuyez sur le siège pour le fixer. (Voir Figure 5)

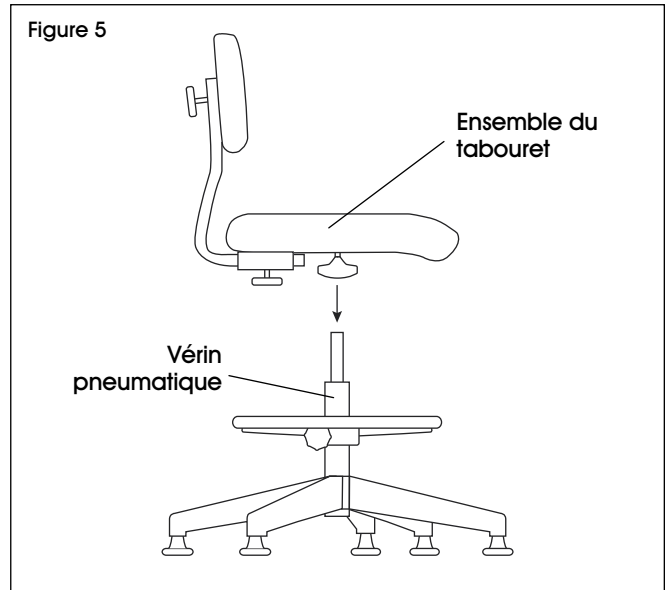

RÉGLAGES DU TABOURET

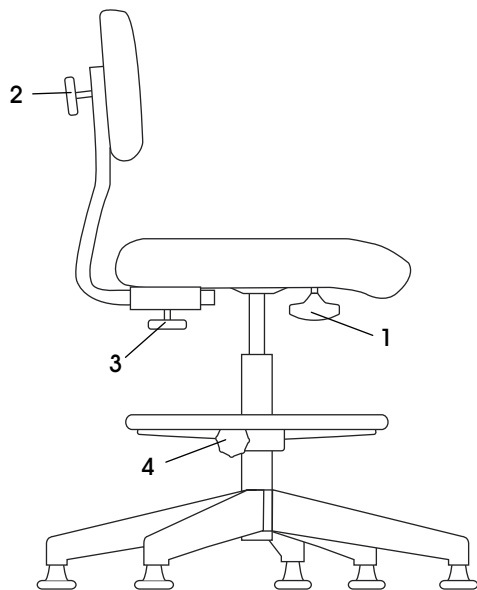

1. Réglage de la hauteur du siège – Pour élever le siège, soulevez le levier avec peu ou sans poids sur le siège. Pour abaisser le siège, soulevez le levier en position assise.
2. Hauteur du dossier – Pour ajuster la hauteur du dossier, desserrez la molette et faites glisser le dossier vers le haut ou le bas. Réglez le dossier à la hauteur désirée et serrez la molette pour le fixer.
3. Profondeur d'assise – Pour régler la profondeur d'assise, desserrez la molette et faites glisser le dossier vers l'intérieur ou l'extérieur. Réglez le dossier à la profondeur d'assise désirée et serrez la molette pour le fixer.
4. Hauteur du repose-pied – Pour ajuster la hauteur du repose-pied, desserrez la molette et faites glisser le repose-pied vers le haut ou le bas. Réglez le repose-pied à la hauteur désirée et serrez la molette pour le fixer.

ULINE

1-800-295-5510
uline.ca